

Product availability: Non-Stock - Not normally stocked in distribution facility

Price\*: 369.00 USD



### Main

Range of product	Modicon M221
Product or Component Type	Logic controller
Discrete output type	Transistor

### Complementary

Discrete I/O number	40
Supply voltage limits	20.4...28.8 V
Inrush current	35 A
Discrete input voltage	24 V
Discrete input voltage type	DC
Analogue input resolution	10 bits
LSB value	10 mV
Discrete output logic	Negative logic (sink)
Maximum size of object areas	8000 %MW memory words 512 %KW constant words 512 %M memory bits 255 %C counters 255 %TM timers
Realtime clock	With
Function Available	PLS PWM Frequency generator
Control signal type	Pulse/Direction Single phase A/B
Marking	CE
Height	3.54 In (90 mm)
Depth	2.76 In (70 mm)
Width	6.30 In (160 mm)
Product Weight	1.39 Lb(US) (0.63 kg)

## Environment

Standards	EN/IEC 60664-1 EN/IEC 61010-2-201 EN/IEC 61131-2
Product Certifications	RCM CULus LR IACS E10 ABS EAC CSA DNV-GL
Environmental characteristic	Ordinary and hazardous location
Immunity to microbreaks	10 Ms
Ambient Air Temperature for Storage	-13...158 °F (-25...70 °C)
Pollution degree	<= 2
Operating altitude	0...6561.68 ft (0...2000 m)
Storage altitude	0.00...9842.52 Ft (0...3000 m)

## Ordering and shipping details

Category	22533 - M2XX PLC & ACCESSORIES
Discount Schedule	MSX
GTIN	3606485408637
Nbr. of units in pkg.	1
Package weight(Lbs)	29.35 Oz (832 g)
Returnability	No
Country of origin	TW

## Packing Units

Unit Type of Package 1	PCE
Package 1 Height	5.63 In (14.3 cm)
Package 1 width	8.27 In (21 cm)
Package 1 Length	4.41 In (11.2 cm)
Unit Type of Package 2	S04
Number of Units in Package 2	12
Package 2 Weight	23.42 Lb(US) (10.624 kg)
Package 2 Height	11.81 In (30 cm)
Package 2 width	15.75 In (40 cm)
Package 2 Length	23.62 In (60 cm)

## Offer Sustainability

Sustainable offer status	Green Premium product
California proposition 65	WARNING: This product can expose you to chemicals including: Lead and lead compounds, which is known to the State of California to cause cancer and birth defects or other reproductive harm. For more information go to <a href="http://www.P65Warnings.ca.gov">www.P65Warnings.ca.gov</a>
REACH Regulation	<a href="#">REACH Declaration</a>
EU RoHS Directive	Pro-active compliance (Product out of EU RoHS legal scope) <a href="#">EU RoHS Declaration</a>
Mercury free	Yes
RoHS exemption information	<a href="#">Yes</a>
China RoHS Regulation	<a href="#">China RoHS Declaration</a>
Environmental Disclosure	<a href="#">Product Environmental Profile</a>
Circularity Profile	<a href="#">End Of Life Information</a>

---

WEEE	The product must be disposed on European Union markets following specific waste collection and never end up in rubbish bins.
PVC free	Yes

---

Dimensions

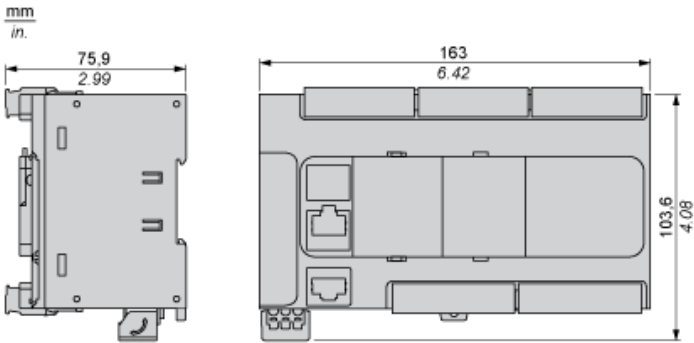

### Mounting on a Rail

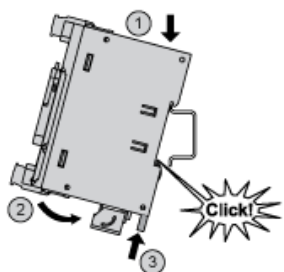

### Direct Mounting on a Panel Surface

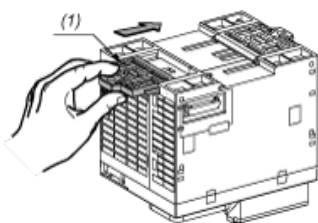

- (1) Install a mounting strip

### Mounting Hole Layout

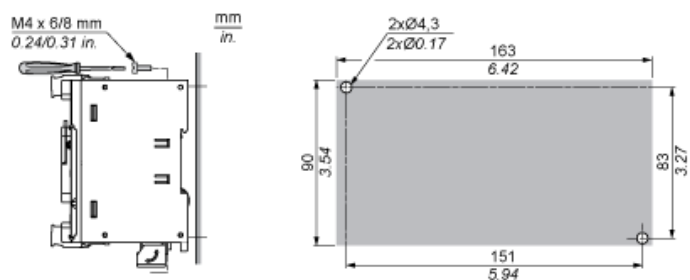

### Mounting

#### Correct Mounting Position

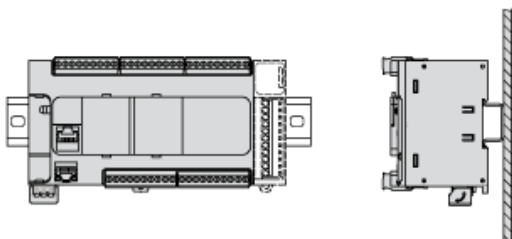

Acceptable Mounting Position

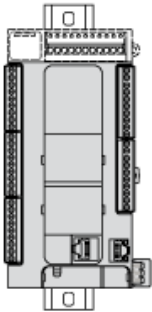

Incorrect Mounting Position

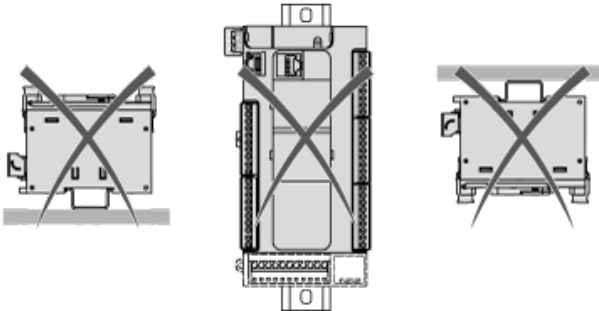

Clearance

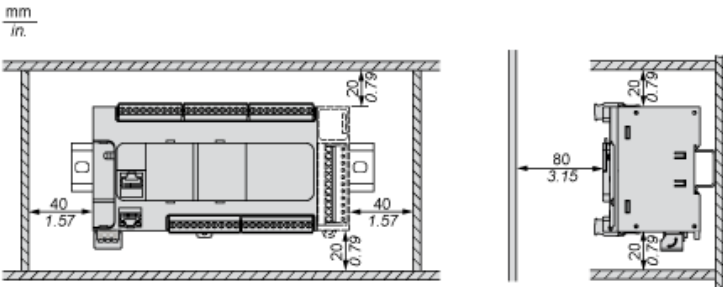

### Digital Inputs

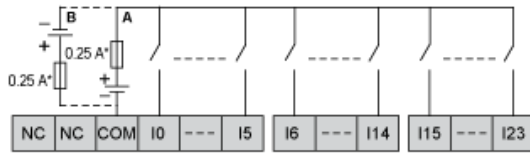

- (\*) Type T fuse
- (A) Sink wiring (positive logic).
- (B) Source wiring (negative logic).

### Connection of the Fast Inputs

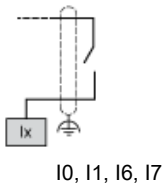

### Transistor Outputs

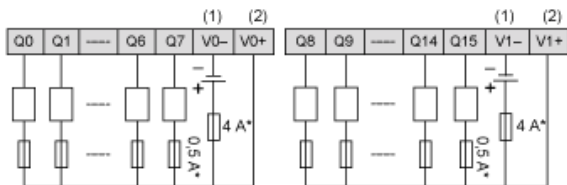

- (\*) Type T fuse
- (1) The V0- and V1- terminals are not connected internally.
- (2) The V0+ and V1+ terminals are not connected internally.

### Connection of the Fast Outputs

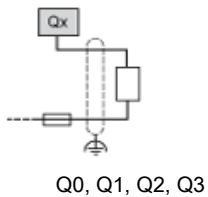

### Analog Inputs

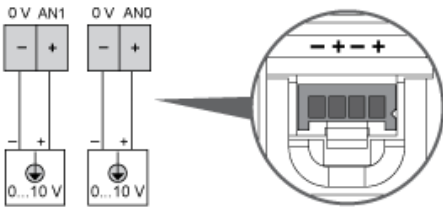
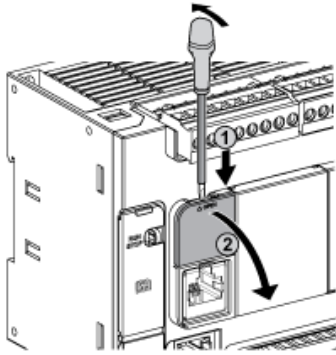

The (-) poles are connected internally.

Pin	Wire Color
0 V	Black
AN1	Red
0 V	Black
AN0	Red

## USB Mini-B Connection

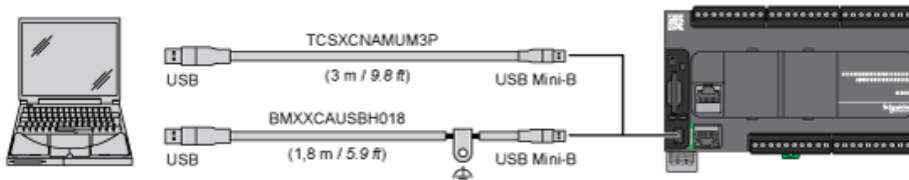

## SL1 Connection

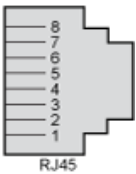

SL1

N °	RS 232	RS 485
1	RxD	N.C.
2	TxD	N.C.
3	RTS	N.C.
4	N.C.	D1
5	N.C.	D0
6	CTS	N.C.
7	N.C.*	5 Vdc

N °	RS 232	RS 485
8	Common	Common

N.C.: not connected

\* : 5 Vdc delivered by the controller. Do not connect.

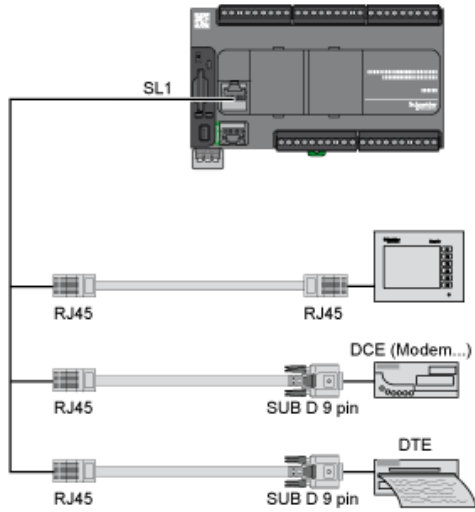

## SL2 Connection

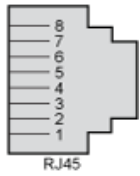

N °	RS 485
1	N.C.
2	N.C.
3	N.C.
4	D1
5	D0
6	N.C.
7	N.C.
8	Common

N.C.: not connected

---

Derating Curves

---

Embedded Digital Inputs (No Cartridge)

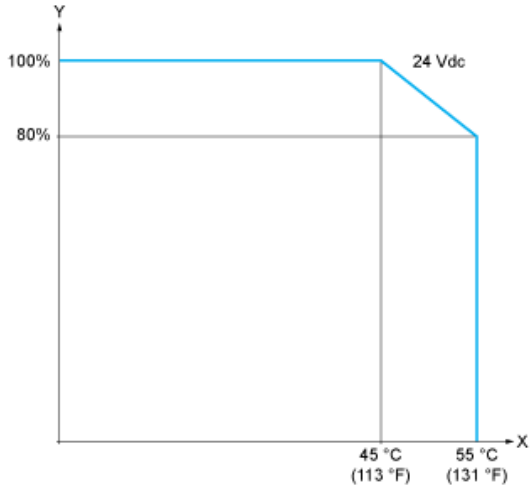

X : Ambient temperature  
Y : Input simultaneous ON ratio

Embedded Digital Inputs (with Cartridge)

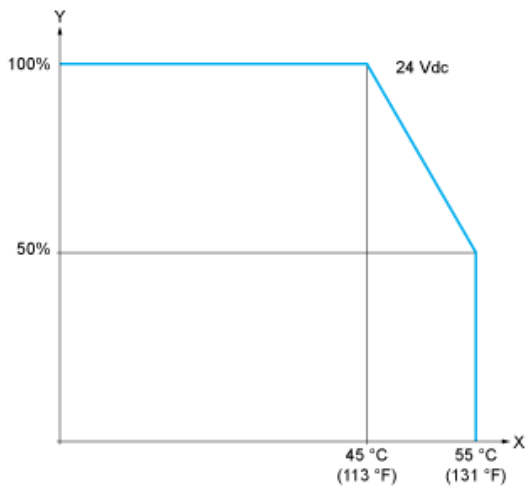

X : Ambient temperature  
Y : Input simultaneous ON ratio

---

Derating Curves

---

### Embedded Digital Outputs (No Cartridge)

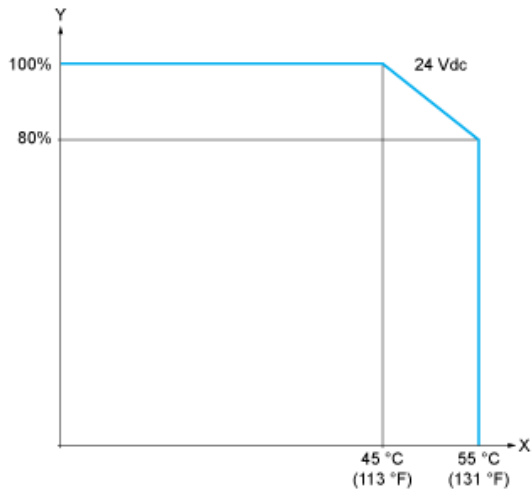

X : Ambient temperature  
Y : Output simultaneous ON ratio

### Embedded Digital Outputs (with Cartridge)

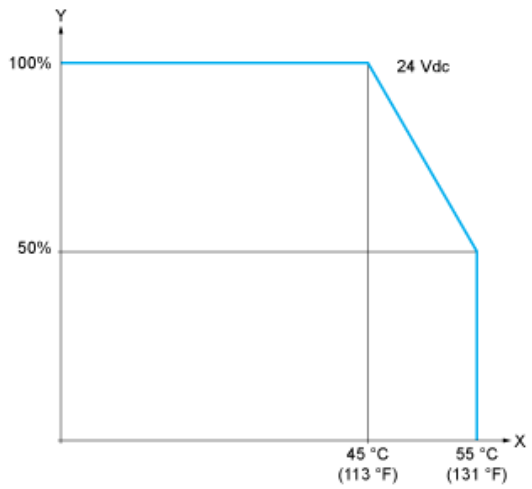

X : Ambient temperature  
Y : Output simultaneous ON ratio

Product Life Status : **Commercialised**